

Burner Collection

24" Burner



Black



Included Accessories



Lighting Rod



Lighter



Funnel

Burner Collection

24" Burner

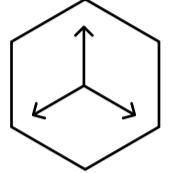
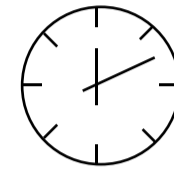
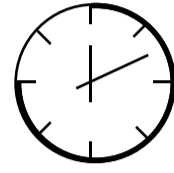
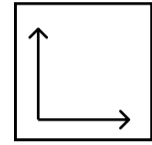
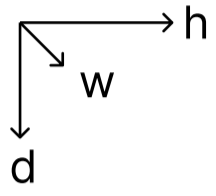

Dimensions H x W x D mm/in	Fuel Capacity	Heats on Average (indoors)	Fuel Consumption	Thermal Output Net (MAX)	Approx. Burn Time	Minimum Room Size (per burner)
114 × 630 × 216 4.5 × 24.8 × 8.5	7.0L	Over 79m ² [850 ft ²]	0.64L per hour	21,500 BTU/h 6.3 Kw	11 hours	150 sq. ft.

Awards

2010 Winner Outdoor Hearth Products Vesta Awards

Application

Indoor & Outdoor

Burner Colour

Stainless Steel
 Black

Materials

Grade 304 Stainless Steel Construction

Approx. Weight

8 lbs

Fuel Type

Bio Ethanol Fuel

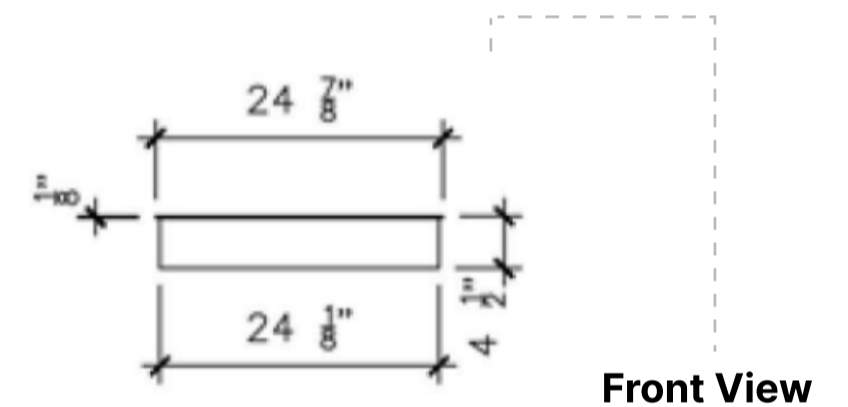

Front View

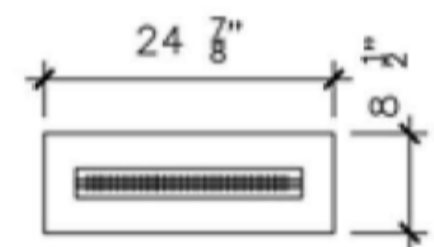

Top View

Inserting within a firebox setting:

The Bio Flame 24" BURNER can only be fitted into a non-combustible firebox that has minimum clearances of 35"W x 20"H x 14"D.

Custom made fireboxes must:

- Be made out of a non-combustible material such as stainless steel
- *When recessing the tray into a non-combustible base with no firebox, the overhead clearance required is 60"MIN. to the nearest combustible*

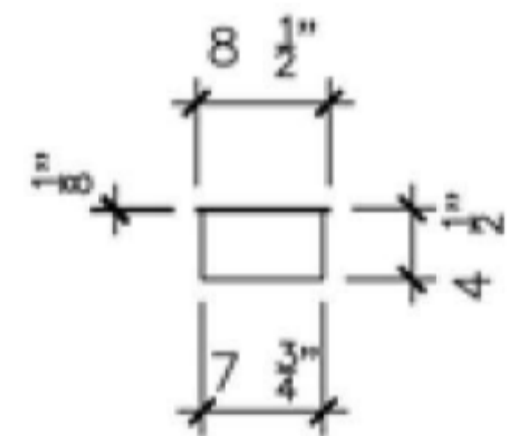

Side View



Global Compliance
All burners are UL Listed in accordance with ANSI/UL1370 in the USA and comply with the ACCC Safety Mandate for Australia.



Lifetime Warranty

FOR MORE INFORMATION PLEASE REFERENCE THE CLEARANCE & INSTALLATION MANUAL

*Dimensions may vary by 2% (plus or minus) due to material attributes. Template not provided. The Bio Flame recommends using the actual fireplace or burner model when making final cut out

