

Firebox Collection

60" Firebox SS



Black



Included Accessories



Lighting Rod



Lighter



Funnel

Firebox Collection

60" Firebox SS

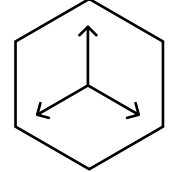
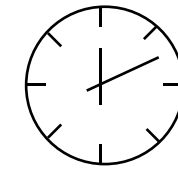
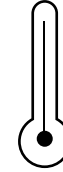
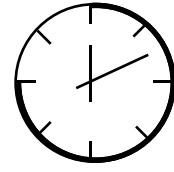
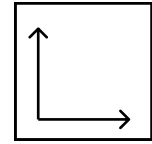
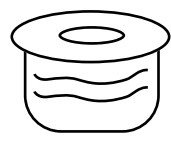
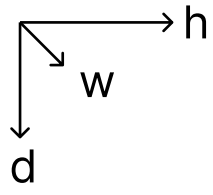

Dimensions H x W x D mm/in	Fuel Capacity	Heats on Average (indoors)	Fuel Consumption	Thermal Output Net (MAX)	Approx. Burn Time	Minimum Room Size (per burner)
672 x 1524 x 381 26.5 x 60.0 x 15.0	14.5L	Over 107m ² [1,152 ft ²]	1.41L per hour	33,500 BTU/h 9.8 Kw	10.3 hours	250 sq. ft.

Awards

2010 Winner Outdoor Hearth Products Vesta Awards

Application

Indoor & Outdoor

Burner Colour

● Stainless Steel ● Black

Materials

Brushed Stainless Steel Internal Frame
8mm Tempered Glass

Burner Size

48" Burner

Fuel Type

Bio Ethanol Fuel

Other

- Double Walled Design
- Fully Insulated
- 304 Stainless Steel Firebox Construction

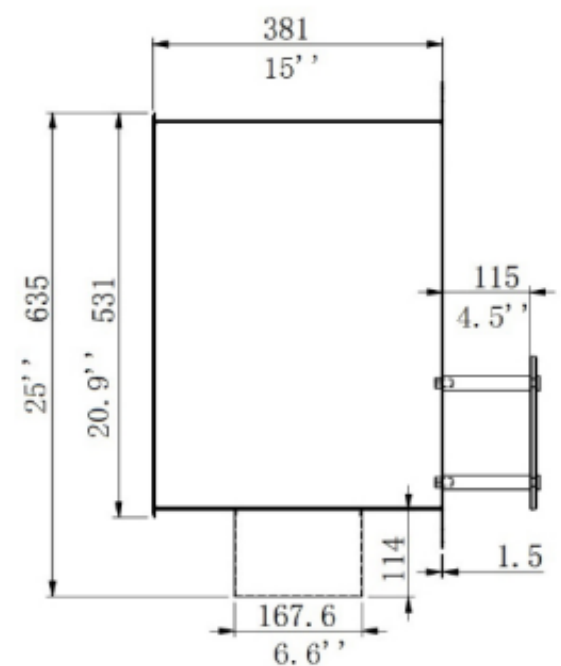

Global Compliance
All burners are UL Listed in accordance with ANSI/UL1370 in the USA and comply with the ACCC Safety Mandate for Australia.



Lifetime Warranty

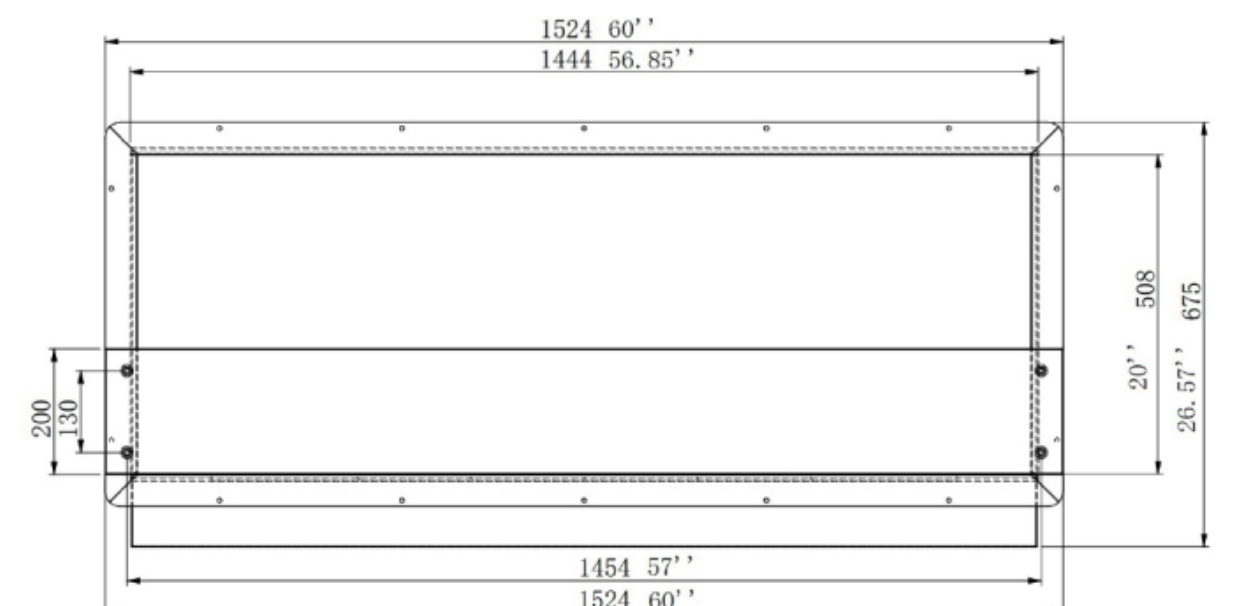

FOR MORE INFORMATION PLEASE REFERENCE THE CLEARANCE & INSTALLATION MANUAL

*Dimensions may vary by 2% (plus or minus) due to material attributes. Template not provided. The Bio Flame recommends using the actual fireplace or burner model when making final cut out

