

# Free Standing Collection Torch 2.0



## Included Accessories

---



# Free Standing Collection Torch 2.0

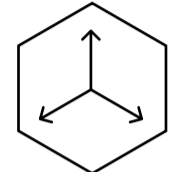
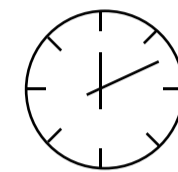
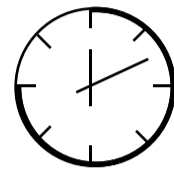
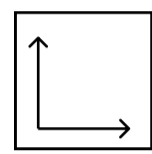
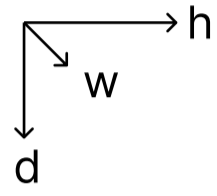

Dimensions H x W x D mm/in	Fuel Capacity	Heats on Average (indoors)	Fuel Consumption	Thermal Output Net (MAX)	Approx. Burn Time	Minimum Room Size (per burner)
1194 x 394 x 394 47.0 x 15.5 x 15.5	0.7L	Over 40m <sup>2</sup> [430 ft <sup>2</sup> ]	0.70L per hour	12,000 BTU/h 3.5 Kw	1 hour	150 sq. ft.

## Awards

2010 Winner Outdoor Hearth Products  
Vesta Awards

## Application

Indoor & Outdoor

## Burner Size

13" Burner

## Materials

Stainless Steel Firebox Construction  
Brushed Stainless Steel Interior  
8mm Tempered Glass

## Approx. Weight

88 lbs

## Fuel Type

Bio Ethanol Fuel

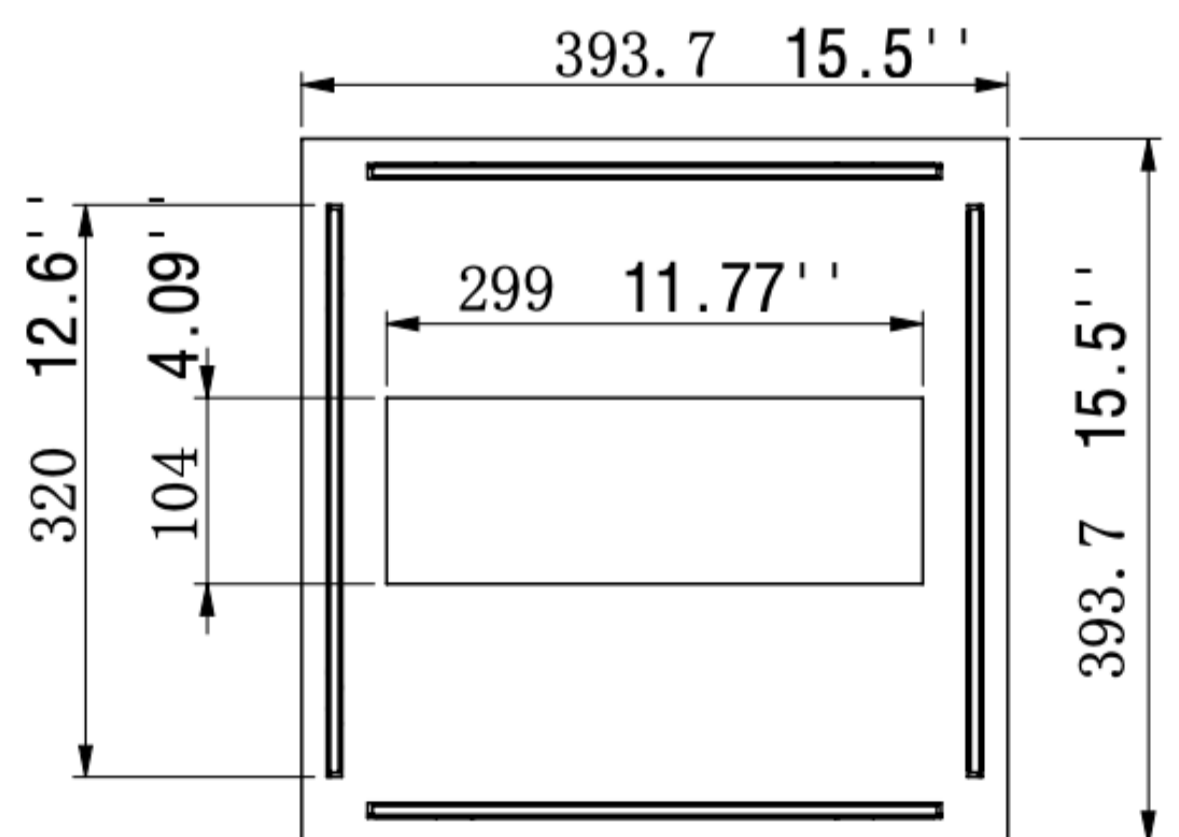
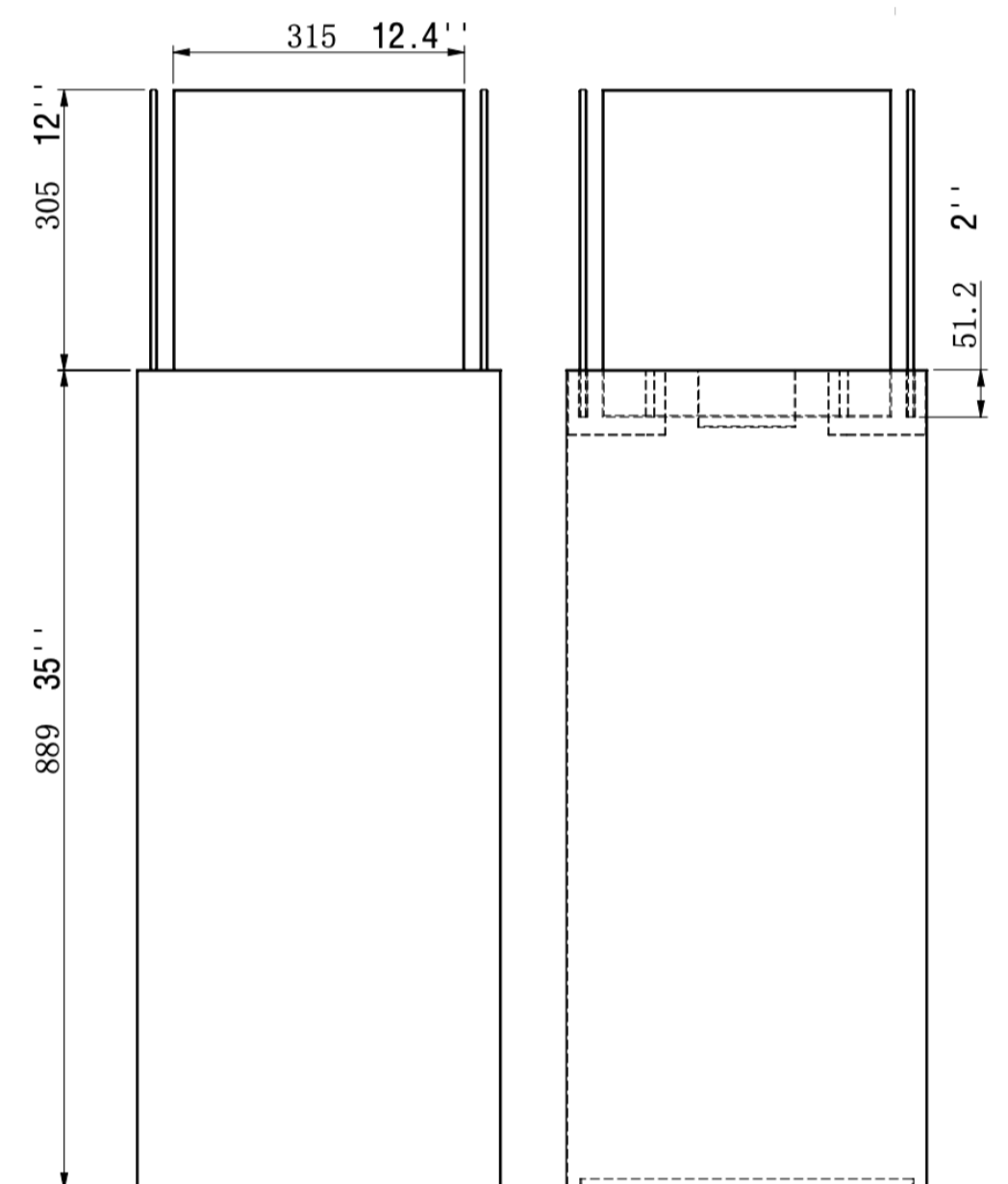

Global Compliance  
All burners are UL Listed in accordance with ANSI/  
UL1370 in the USA and comply with the ACCC Safety  
Mandate for Australia.



Lifetime Warranty

**FOR MORE INFORMATION PLEASE REFERENCE THE CLEARANCE & INSTALLATION MANUAL**

\*Dimensions may vary by 2% (plus or minus) due to material attributes. Template not provided. The Bio Flame recommends using the actual fireplace or burner model when making final cut out

