

# Firebox Collection

## XL Firebox DS

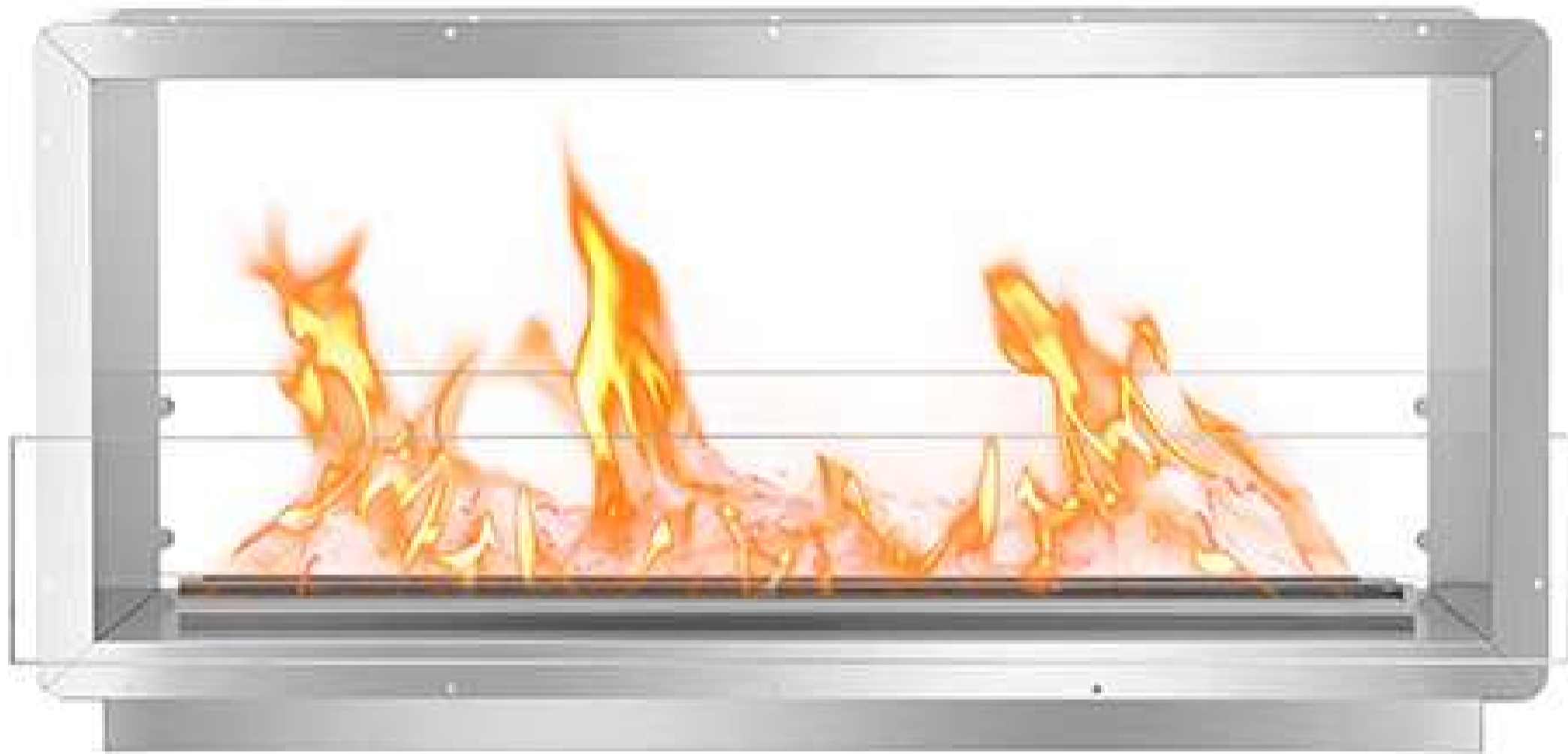

**Black**



### Included Accessories



**Lighting Rod**



**Lighter**



**Funnel**

# Firebox Collection

## XL Firebox DS

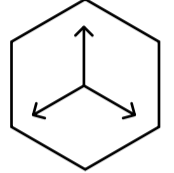
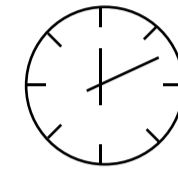
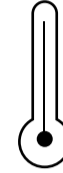
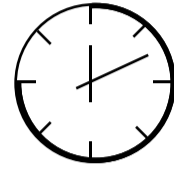
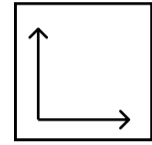
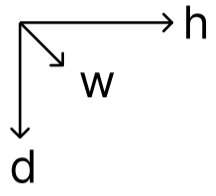
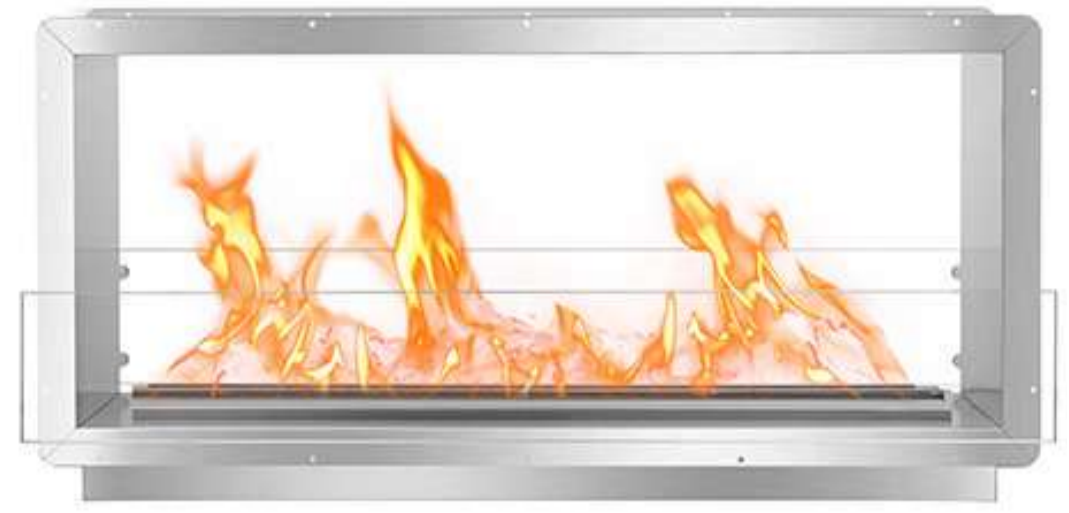

Dimensions H x W x D mm/in	Fuel Capacity	Heats on Average (indoors)	Fuel Consumption	Thermal Output Net (MAX)	Approx. Burn Time	Minimum Room Size (per burner)
658 × 1300 × 376 25.8 × 51.2 × 14.8	11L	Over 93m <sup>2</sup> [1,001 ft <sup>2</sup> ]	1L per hour	27,000 BTU/h 7.9 Kw	11 hours	150 sq. ft.

### Awards

2010 Winner Outdoor Hearth Products  
Vesta Awards

### Application

Indoor & Outdoor

### Burner Colour

● Stainless Steel ● Black

### Materials

Brushed Stainless Steel Internal Frame  
8mm Tempered Glass

### Burner Size

38" Burner

### Fuel Type

Bio Ethanol Fuel

### Other

- Double Walled Design
- Fully Insulated
- 304 Stainless Steel Firebox Construction

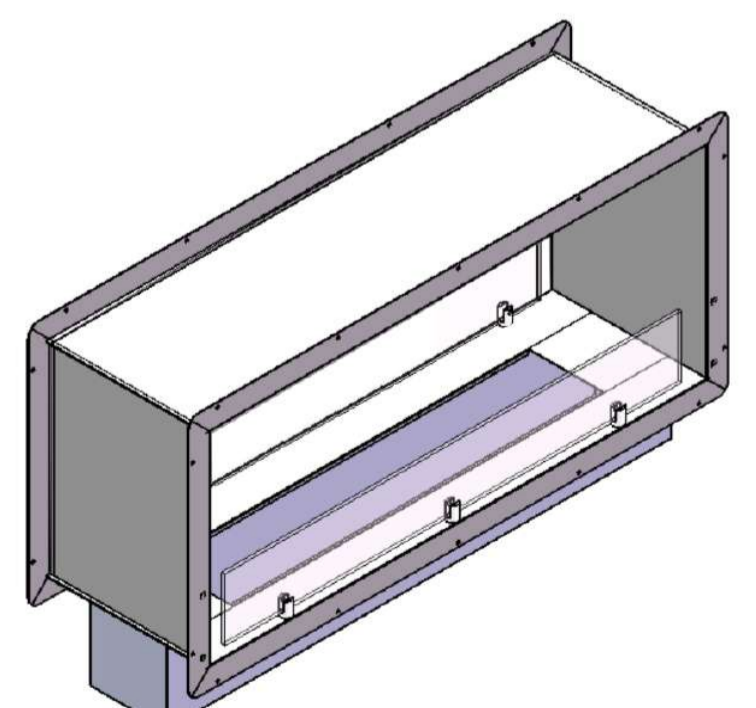
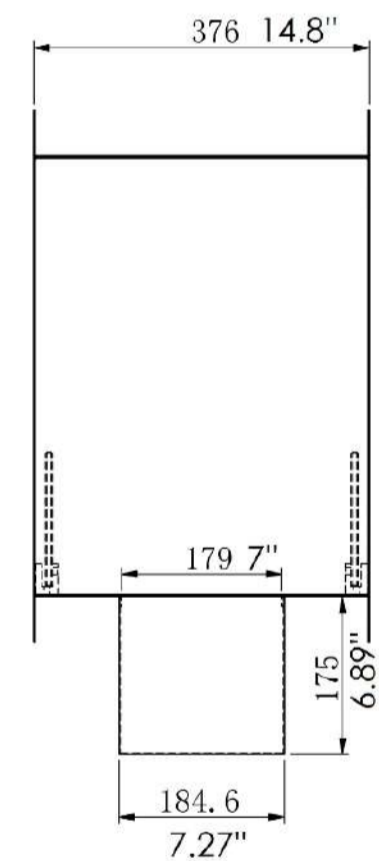
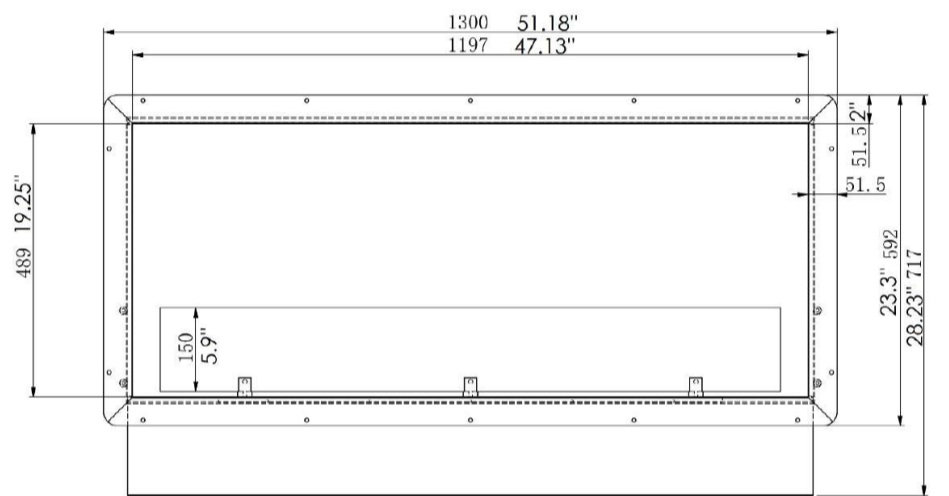

Lifetime Warranty

**FOR MORE INFORMATION PLEASE REFERENCE THE CLEARANCE & INSTALLATION MANUAL**

\*Dimensions may vary by 2% (plus or minus) due to material attributes. Template not provided. The Bio Flame recommends using the actual fireplace or burner model when making final cut out

